

PERSPECTIVES

TIMELINE

A brief history of synthetic biology

D. Ewen Cameron, Caleb J. Bashor and James J. Collins

Abstract | The ability to rationally engineer microorganisms has been a long-envisioned goal dating back more than a half-century. With the genomics revolution and rise of systems biology in the 1990s came the development of a rigorous engineering discipline to create, control and programme cellular behaviour. The resulting field, known as synthetic biology, has undergone dramatic growth throughout the past decade and is poised to transform biotechnology and medicine. This Timeline article charts the technological and cultural lifetime of synthetic biology, with an emphasis on key breakthroughs and future challenges.

The founding of the field of synthetic biology near the turn of the millennium was based on the transformational assertion that engineering approaches — then mostly foreign to cell and molecular biology — could be used both to study cellular systems and to facilitate their manipulation to productive ends. Now more than a decade old, synthetic biology has undergone considerable growth in scope, expectation and output, and has become a widely recognized branch of biological research¹. In many aspects, the trajectory of the field during its first decade of existence has been non-linear, with periods of meaningful progress matched by episodes of inertia as design efforts have been forced to re-orient when confronted with the complexity and unpredictability of engineering inside living cells.

Although a consensus has yet to be reached on a precise definition of synthetic biology, the use of molecular biology tools and techniques to forward-engineer cellular behaviour has emerged as a broad identity for the field, and a set of common engineering approaches and laboratory practices have developed, along with a vibrant community culture. Much of the foundational work in the field was carried out in the model microbial species *Escherichia coli* and *Saccharomyces cerevisiae*, and these microbial systems remain central in several focal areas of the field, including complex circuit design, metabolic engineering, minimal genome construction and cell-based therapeutic

strategies. In this Timeline article, we focus on efforts in synthetic biology that deal with microbial systems; work in mammalian synthetic biology has been recently reviewed elsewhere^{2,3}.

In this Timeline article, a brief history of some of the major events that have shaped synthetic biology since its inception are presented. We begin by describing the unique interdisciplinary dynamics of the 1990s that, by the end of the decade, had enticed engineers from disciplines outside biology to enter the wet lab and begin tinkering with cellular networks. We divide a chronology of the field into three distinct periods and highlight scientific and cultural milestones for each period (FIG. 1 (TIMELINE)): first, a foundational period, in which many of the characteristic experimental and cultural features of the field were established; second, an intermediate period, which was characterized by an expansion of the field but a lag in engineering advances; and third, a recent era of accelerated innovation and shifting practices, in which new technologies and engineering approaches have enabled us to advance towards practical applications in both biotechnology and medicine.

1961–1999: origins of the field

The roots of synthetic biology can be traced to a landmark publication by Francois Jacob and Jacques Monod in 1961 (REF. 4). Insights from their study of the *lac* operon in *E. coli* led them to posit the existence of regulatory

circuits that underpin the response of a cell to its environment. The ability to assemble new regulatory systems from molecular components was soon envisioned⁵, but it was not until the molecular details of transcriptional regulation in bacteria were uncovered in subsequent years⁶ that a more concrete vision, based on programmed gene expression, began to take shape.

Following the development of molecular cloning and PCR in the 1970s and 1980s, genetic manipulation became widespread in microbiology research, ostensibly offering a technical means to engineer artificial gene regulation. However, during this pre-genomic period, research approaches that were categorized as genetic engineering were mostly restricted to cloning and recombinant gene expression. In short, genetic engineering was not yet equipped with the necessary knowledge or tools to create biological systems that display the diversity and depth of regulatory behaviour found in microorganisms.

By the mid-1990s, automated DNA sequencing and improved computational tools enabled complete microbial genomes to be sequenced, and high-throughput techniques for measuring RNA, protein, lipids and metabolites enabled scientists to generate a vast catalogue of cellular components and their interactions. This ‘scaling-up’ of molecular biology generated the field of systems biology, as biologists and computer scientists began to combine experimentation and computation to reverse-engineer cellular networks^{7–9}. What emerged from this enormous and continuing basic research effort was a view that cellular networks, although vast and intricate, were organized as a hierarchy of clearly discernable functional modules, similar to many engineered systems¹⁰.

Gradually, it was recognized that the rational manipulation of biological systems, either by systematically tuning or rearranging their modular molecular constituents, could form the basis of a formal biological engineering discipline¹¹. As a complement to the top-down approach of systems biology, a bottom-up approach was envisioned, which could draw on an ever-expanding list of molecular ‘parts’ to forward-engineer regulatory networks. Such an approach could be

Timeline | A brief history of synthetic biology

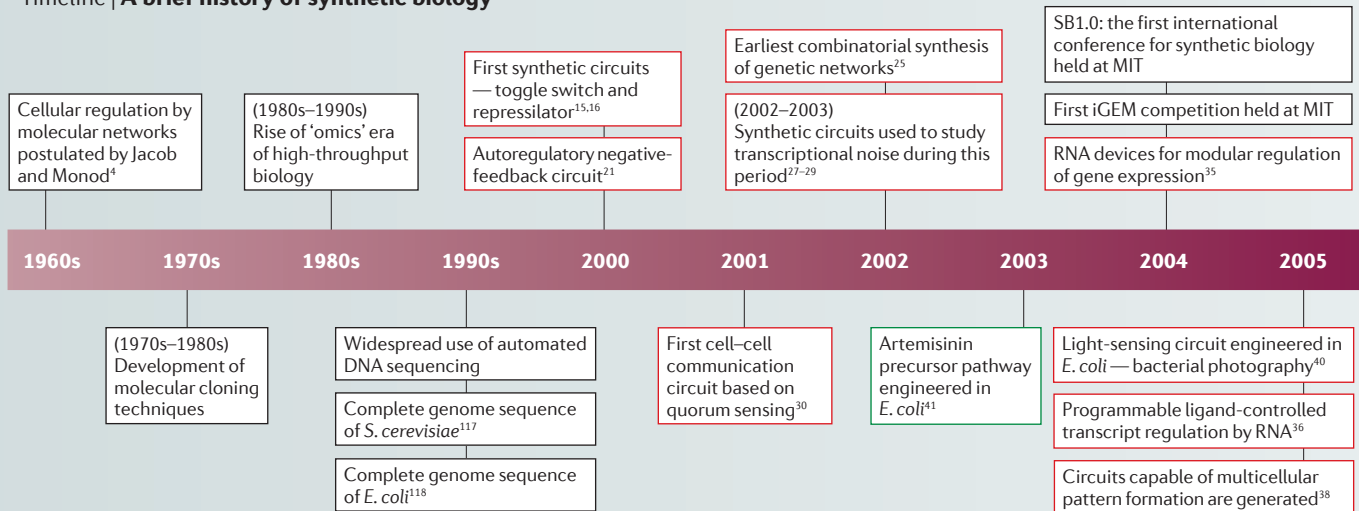

Key to coloured boxes: technical or cultural milestones (black); circuit engineering (red); synthetic biology in metabolic engineering (green); therapeutic applications (blue); whole genome engineering (purple). *E. coli*, *Escherichia coli*; iGEM, International Genetically Engineered Machine; MAGE, multiplex automated genome engineering; MIT, Massachusetts Institute of Technology; SB1.0, Synthetic Biology 1.0; *S. cerevisiae*, *Saccharomyces cerevisiae*.

used both to study the functional organization of natural systems and to create artificial regulatory networks that have potential biotechnology and health applications¹². By the end of the 1990s, a small group of engineers, physicists and computer scientists recognized the opportunity and began to migrate into molecular biology to try their hand at the bench.

2000–2003: the foundational years

A convenient starting point for early synthetic biologists was the creation of simple gene regulatory circuits that carry out functions in an analogous manner to electrical circuits^{13,14}. The dynamics of these simple genetic circuits could be described using correspondingly simple mathematical models, enabling circuit engineers to evaluate the merits of a model-based design approach. The molecular biology workhorse — *E. coli* — was an ideal testbed for this work owing to our deep mechanistic understanding of its biology, its ease of genetic manipulation and the relatively large number of well-studied gene regulatory systems that provided a convenient initial source of circuit ‘parts’.

In the first month of the new millennium (January 2000), the first reports of genetic circuits that had been engineered to carry out designed functions were published. In one example, Collins and colleagues constructed a genetic toggle switch containing promoters that drive the expression of mutually inhibitory transcriptional repressors¹⁵ (FIG. 2a). Cells that harboured the circuit could toggle between two stable expression

states in response to external signals. In another example, Elowitz and Leibler engineered an oscillatory circuit that consisted of a triple negative-feedback loop of sequential repressor–promoter pairs¹⁶ (FIG. 2b). Activation of the circuit, termed the repressilator, resulted in the ordered, periodic oscillation of repressor protein expression.

Both the toggle and repressilator were constructed from a similar set of parts (for example, inducible promoter systems) and used GFP expression as an output to monitor circuit behaviour. Model-based design was used in each case, but agreement between the model and the experimental output was reached only after ‘tuning’ the circuits by iteratively replacing parts to obtain the desired behaviour. The engineering workflow that was established by these studies, which incorporated quantitative design, physical construction, experimental measurement and hypothesis-driven debugging, remains a characteristic feature of synthetic circuit construction^{17–19}.

In the period that immediately followed the publication of the toggle and repressilator papers, several studies used circuit engineering to investigate the relationship between network design and quantitative behaviour²⁰. Among circuits from this period were simple autoregulatory negative- and positive-feedback modules^{21–23} (FIG. 2c) and a relaxation-based gene oscillator that featured a different circuit architecture from the repressilator and exhibited more stable oscillatory behaviour²⁴. Leibler and colleagues used a small library of transcriptional

regulators to combinatorially assemble genetic circuits that display diverse logic gate behaviour²⁵. Seminal work by Weiss and colleagues established methods for engineering transcription-based logic gates and did much to formalize the language and practice of circuit engineering²⁶. Simple circuits that explored the relationship between gene expression and molecular noise in both prokaryotic and eukaryotic genes provided an early glimpse into the role that synthetic systems could have in clarifying and expanding our understanding of basic biology^{27–29}.

Although mostly focused on circuit engineering, efforts during this early period began to push beyond simple gene regulatory networks. The first cell–cell communication circuits were developed³⁰, foretelling a move towards engineered microbial consortia in the years to come. In addition, the earliest efforts to rewire post-translational regulation using protein–protein interaction domains and scaffold proteins were demonstrated in *S. cerevisiae*³¹.

2004–2007: expansion and growing pains

The size and scope of the synthetic biology field began to increase dramatically in the mid-2000s. The first international conference for the field, Synthetic Biology 1.0 (SB1.0), was held in the summer of 2004 at the Massachusetts Institute of Technology (MIT), USA. Bringing together researchers from biology, chemistry, physics, engineering and computer science, the meeting was widely lauded for its positive impact on the nascent field, helping to create

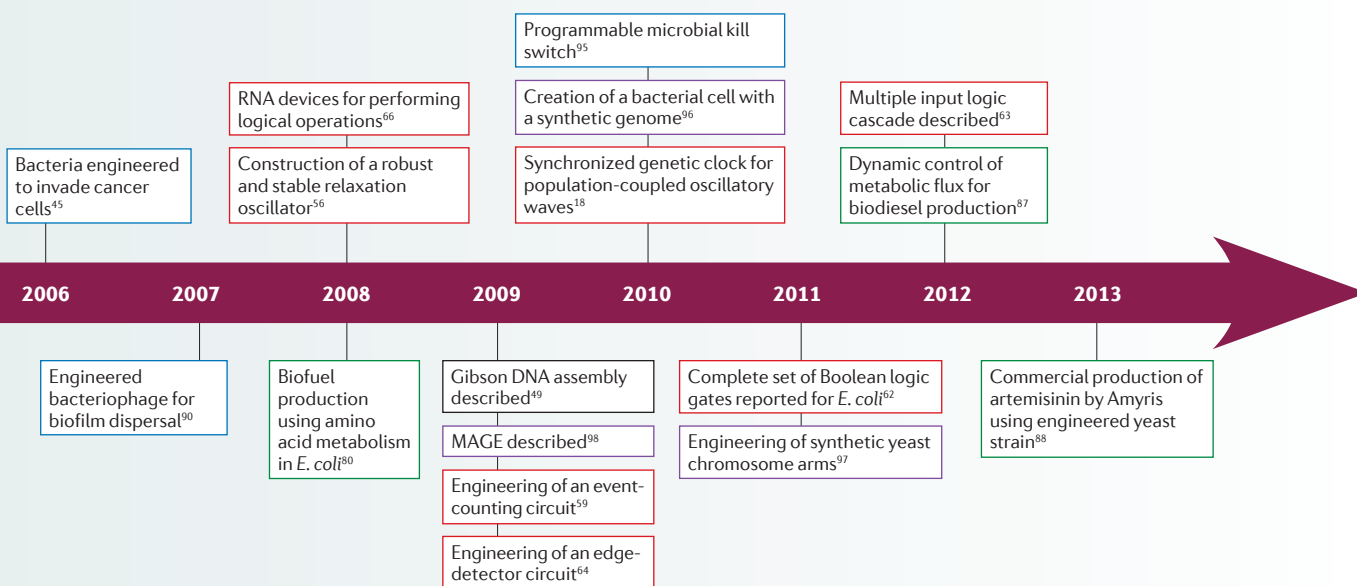

an identifiable community and galvanize efforts towards the design, construction and characterization of biological systems, with the long-term goal of whole-genome engineering^{32,33}. As the highly interdisciplinary community began to coalesce, ideas from contemporary engineering were broadly infused into molecular biology research for the first time, raising questions about the compatibility of the two fields. Could synthetic biology evolve into a sophisticated engineering discipline on par with electrical or mechanical engineering? Could practices like parts standardization and concepts like abstraction hierarchies be mapped onto biological systems? For the first time, groups began to make explicit attempts to improve the engineering of genetic systems by creating collections of modular parts and developing methods to construct and tune particular circuit designs³⁴.

Notable breakthroughs. Important milestones in parts and circuit design in *E. coli* continued to emerge during this period, including RNA-based systems that expanded synthetic circuit design from mainly transcriptional control into post-transcriptional and translational control mechanisms^{35,36} (FIG. 3a). Novel parts and circuit designs continued to appear, such as an AND logic gate based on the transcription of a gene for which translation is dependent on the co-transcription of an engineered tRNA³⁷ (FIG. 3b). Quorum-sensing circuitry was further engineered to enable multicellular patterning^{38,39}, and a sensory circuit was

developed to convert light into gene expression in a field of cells⁴⁰ (FIG. 3c).

Perhaps the most high-profile scientific success during this period occurred in metabolic engineering, in which the forward-engineering principles of synthetic biology converged with decades of basic research on isoprenoid biosynthesis to enable the heterologous production of precursors to artemisinin — a widely used antimalarial drug that is naturally produced by the sweet wormwood plant *Artemisia annua*^{41,42}. Along with promising work on the rational design of complex polyketides and non-ribosomal peptides^{43,44}, these efforts led to an increased appreciation for the scope of potential commercial applications for synthetic biology. A synthetic circuit that promotes bacterial invasion of tumour cells was an early example of a cell-based therapeutic strategy to improve human health⁴⁵.

Formidable obstacles. As researchers attempted to incorporate new parts and build circuits of increased complexity, it soon became clear that several major bottlenecks were holding back the field. First, efficient methods to assemble individual genetic parts into complex circuits had not been developed, resulting in the tedious, *ad hoc* assembly of most new circuit designs. Second, the lack of established methods to characterize genetic part functionality resulted in a disproportionate amount of time and effort spent on tweaking and redesigning constructed circuits to enable them to function properly. Finally, owing to the

ad hoc nature of this optimization process, functional circuits often contained parts that remained uncharacterized, resulting in laborious re-characterization when the parts were introduced into new circuits⁴⁶.

An early effort in the field to tackle the storage and assembly issues was the Registry of Standard Biological Parts (RSBP; see further information) — a public repository that was developed to digitally catalogue and physically store genetic parts in a standardized ‘BioBrick’ format that facilitates the stepwise, methodical assembly of the parts into larger circuits⁴⁷. Although the subsequent development of one-step assembly methods, such as Golden Gate⁴⁸ and Gibson Assembly⁴⁹, has mostly restricted the use of BioBrick assembly to iGEM (International Genetically Engineered Machine — which is an undergraduate synthetic biology competition; see further information), RSBP and other parts registries have proven to be important sequence databases for the larger community. Translation of these registries to the computational language Synthetic Biology Open Language (SBOL; see further information) has given software tools a standard format to describe synthetic parts and circuit designs and facilitate their exchange⁵⁰. OpenWetWare (see further information), which is a public wiki originally developed at MIT, USA, has grown to be a valuable resource for the synthetic biology community, serving as a forum to share protocols and host laboratory websites.

Parts characterization proved to be a more confounding hurdle. In many cases,

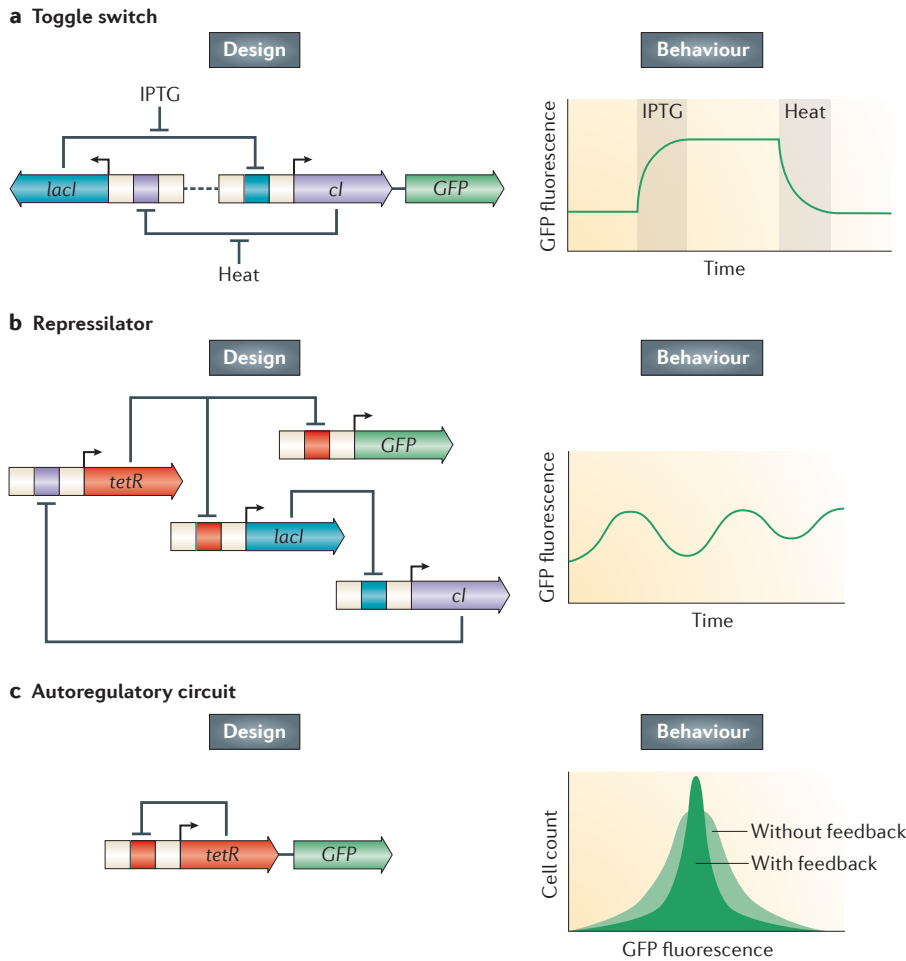

Figure 2 | Examples of gene circuits reported during the foundational years of synthetic biology (2000–2003). **a** | The toggle switch. A pair of repressor genes (*lacI* and *cl*) are arranged to antagonistically repress transcription of each other, resulting in a bistable genetic circuit in which only one of the two genes is active at a given time. The toggle can be ‘flipped’ to the desired transcriptional state using environmental inputs to disengage one of the repressors from its operator (for example, IPTG (isopropyl- β -D-thiogalactoside) is used to disengage LacI and heat is used to disengage cl). Once the input is removed, the desired transcriptional state persists for multiple generations. **b** | The repressilator. The circuit is constructed from three repressor–promoter interactions (between *cl*, LacI and TetR repressors and their associated promoters), which are linked together to form a ring-shaped network, in which TetR regulates a GFP-reporter node. When analysed at the single-cell level using time-lapse fluorescence microscopy, the circuit exhibits periodic oscillations in GFP expression, which persist for a number of generations; however, oscillations become dampened after a few periods and are generally noisy, with individual cells showing high variability in both the amplitude and period of their oscillations. **c** | Autoregulatory circuit. In this circuit, TetR-mediated negative-feedback regulation of its own transcription results in a narrow population-wide expression distribution, as measured by the co-transcribed GFP reporter. The circuit demonstrates a principle that was long-appreciated in control-systems engineering and nonlinear dynamics — that noise in a system can be reduced by introducing negative feedback.

even relatively well-characterized parts failed to function in a predictable manner when taken out of the specific genetic or environmental context in which they were originally characterized, and they frequently failed to function properly when placed into circuits with other parts⁵¹. The difficulty in addressing these parts-interoperability and context-dependency issues contributed to a relative stagnation in complex circuit development.

As a result, synthetic biologists continued to use relatively simple circuit designs⁵².

In the mid-2000s, synthetic biology began to receive widespread recognition in both the scientific and popular press, and the rapid expansion of iGEM played an important part in garnering interest in the field within universities and from the general public^{53,54}. Funding agencies also began to follow suit, particularly the US National

Science Foundation, which provided funding for SynBERC (Synthetic Biology Engineering Research Project; see further information) — a consortium of synthetic biology laboratories from several leading academic institutions in the United States. The field also became increasingly international during these years, as conferences, such as SB3.0 in Zurich, Switzerland, and SB4.0 in Hong Kong, China, helped to globalize the synthetic biology community.

2008–2013: increase in pace and scale

In contrast to the slow progress that characterized circuit engineering during the preceding time period, the field has undergone a dramatic maturation in both the pace and the quality of output in recent years. Beginning in 2008, published reports began to appear describing circuits that exhibited a higher degree of complexity, that were constructed using a broader array of better-characterized parts and that exhibited more precise and varied behaviours. Although the context-dependence and interoperability of parts continued to place a general drag on circuit engineering, several improvements in engineering practices throughout the field functioned as a counterbalance to increase productivity. Indeed, many of the research groups that entered the field in the earlier part of the decade began to sharpen their craft in the mid-2000s, making use of better technical understanding, design approaches and construction methods. High-throughput DNA-assembly methods, coupled with the steady decline in gene-synthesis costs, further accelerated the build phase of circuit engineering^{48,49,55}.

A circuit that showed robust, persistent oscillatory behaviour was developed by Hasty and colleagues in 2008, and was an impressive update to a series of experimental and theoretical studies on the design of oscillatory circuits⁵⁶ (FIG. 4a). The authors combined quantitative modelling with a robust circuit design and characterized circuit performance using a microfluidics platform. In subsequent work, a similar circuit architecture was coupled with quorum sensing to enable population-wide synchronization of circuit oscillations⁵⁷. Incorporation of a gas-phase redox signalling system enabled oscillatory behaviour to be extended to centimetre-length scales⁵⁸.

A pair of synthetic gene circuits that count events — a long-stated goal for circuit engineers — was reported in 2009 (REF. 59). For one of these counter circuits, recombinase-mediated DNA rearrangement was used to create permanent memory of an

a Modular riboregulator

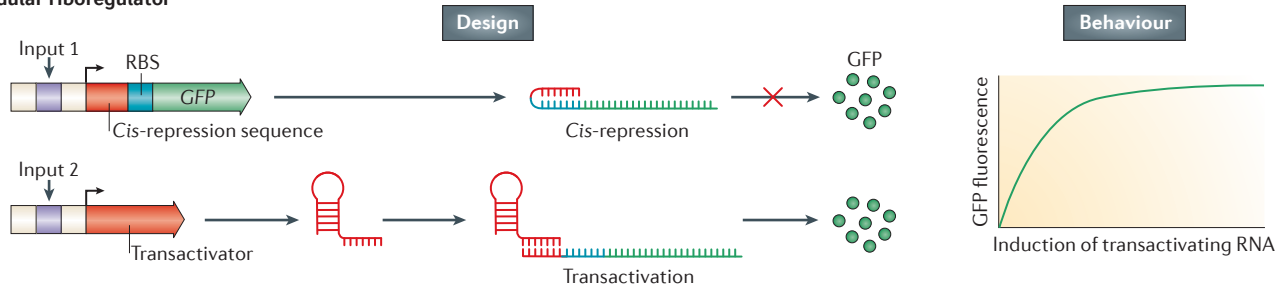

b Two-input AND gate

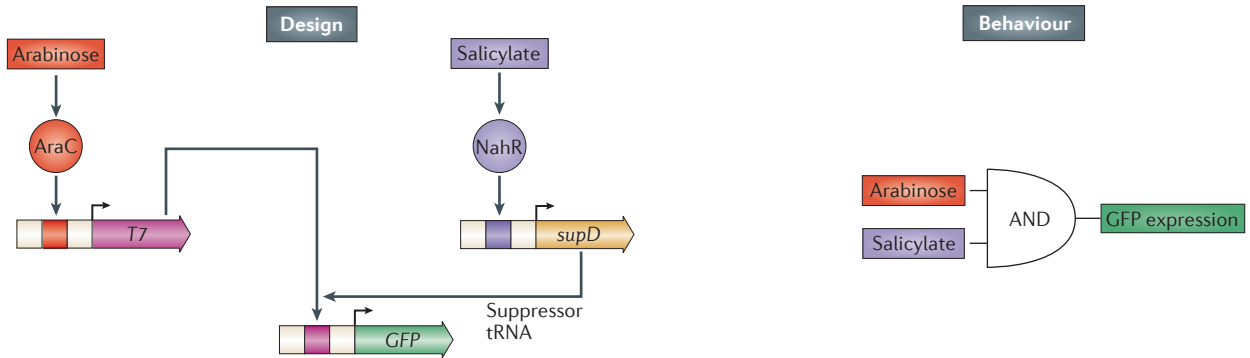

c Multicellular pattern formation

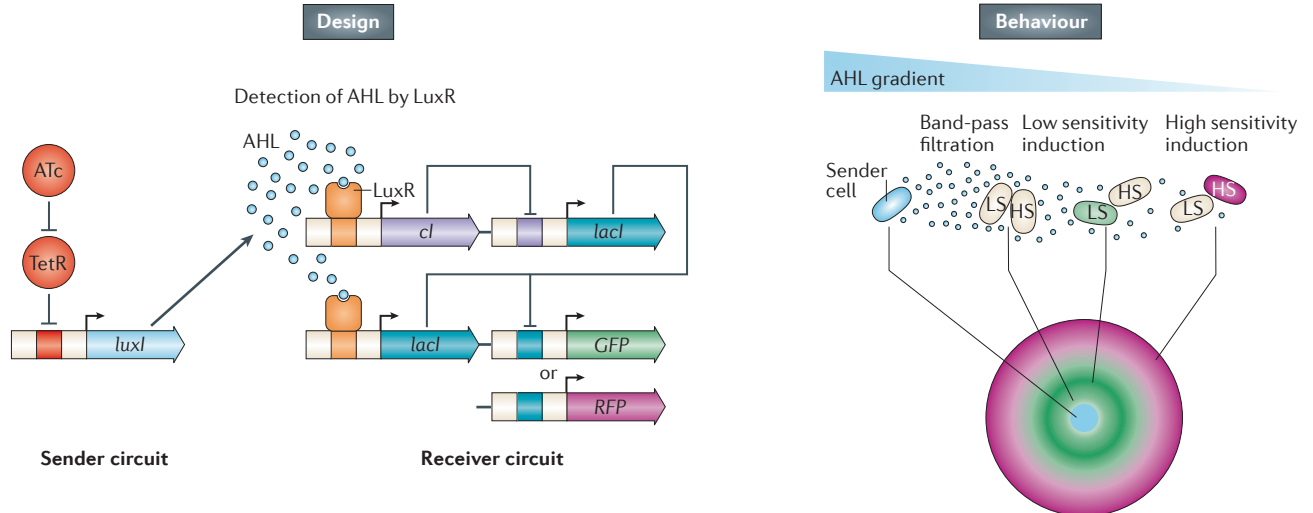

Figure 3 | Examples of gene circuits reported during the intermediate years of synthetic biology (2004–2007).

a | Modular riboregulator. A *cis*-repression sequence is appended to the 5' UTR of a gene transcript to inhibit translation by blocking the ribosome binding site (RBS). Translation inhibition is reversed by the expression of an inducible transactivating sequence that tightly binds to the *cis*-repression sequence, thereby exposing the RBS to enable translation of GFP. **b** | Two-input AND gate. One of the first examples of the successful programming of logical operations in a cell was an AND-gate circuit in which simultaneous exposure of cells to two external inputs was converted into a transcriptional output. In response to arabinose, AraC-mediated induction of one promoter results in the transcription of a T7 polymerase that is engineered to contain two TAG (amber) stop codons in its coding sequence. The second promoter, which is activated by NahR in the presence of salicylate, controls the transcription of SupD, which is an amber suppressor tRNA that recognizes the TAG stop codon and adds a serine residue to the nascent polypeptide, enabling read-through translation of the T7 polymerase.

c | Multicellular pattern formation. The circuit, which was engineered to produce an ordered pattern on a two-dimensional field of bacterial cells, consists of genetic parts derived from *Vibrio fischeri*: LuxI, which is an enzyme that produces the quorum-sensing molecule acyl homoserine lactone (AHL), is expressed in 'sender' cells, whereas 'receiver' cells express LuxR, which is an AHL-sensitive transcriptional activator. By coupling LuxR function to a feedforward circuit architecture, receiver cells are programmed for bandpass detection of AHL, and fluorescent reporter gene expression is activated only at discreet concentrations of AHL. Adjusting the sensitivity of LuxR activation results in strains that have high-sensitivity (HS) or low-sensitivity (LS) AHL detection capabilities. HS and LS receiver strains are programmed with red fluorescent protein (RFP) and GFP output, respectively, and mixed together in a bacterial lawn in which sender cells are placed in the middle. This results in the emergence of a banded, bullseye pattern of fluorescent-reporter expression.

event, and a similar strategy was later used to engineer a full set of recombinase-based logic gates^{60,61} (FIG. 4b). Comprehensive engineering of robust transcriptional logic was achieved in *E. coli*, including all 16 elementary logic gates⁶², as well as the engineering of a multiple input logic network using a multitier transcriptional cascade⁶³. Another notable achievement from this period was work that extended the capability of bacterial light-sensing circuitry to programme a genetic edge-detection circuit⁶⁴ (FIG. 4c) and circuits that used quorum sensing-dependent flagellar motility to enable population-wide pattern formation in *E. coli*⁶⁵.

RNA-based circuit engineering also underwent an expansion during this period,

as biosensing functions gave way to RNA-based computation. RNA devices were built to control the regulatory logic of gene expression⁶⁶, and RNA design tools were developed to enable the precise, predictable control of heterologous and endogenous gene targets^{67,68}. The CRISPR–Cas (clustered, regularly interspaced short palindromic repeats–CRISPR-associated proteins) immunity system in bacteria and archaea was also re-purposed to enable genome-wide transcriptional control. Type II CRISPR–Cas systems use RNA-directed DNA binding by the nuclease Cas9 to detect and cleave invading bacteriophage and other horizontally transferred DNA⁶⁹, and independent groups developed Cas9 nuclease mutants that enable RNA-directed DNA binding by Cas9 without subsequent DNA cleavage^{70–72}. The DNA-binding specificity of Cas9 is defined by an RNA-targeting sequence, which enables Cas9 to be targeted to almost any genomic or episomal sequence. By fusing a transcription activator or repressor to Cas9, the system can be used to regulate transcription of the targeted gene or operon.

Post-translational control systems began to appear during this period. Synthetic protein scaffolds were used to introduce new circuit feedback connections in order to predictably alter the dynamic behaviour of a native yeast mitogen-activated protein (MAP) kinase pathway⁷³. In separate studies in *E. coli*, synthetic scaffolds were used to reroute two-component signalling⁷⁴ and, in another study, to colocalize mevalonate biosynthetic pathway enzymes, improving glucaric acid yield and reducing the toxicity of intermediate metabolites⁷⁵. Chau and colleagues used protein signalling circuits to produce spatial polarization in yeast by engineering circuits from components that self-organize into localized distributions⁷⁶. This study was a crucial step towards the systematic control of complex phenotypes such as cell shape and movement. In the near-term, such circuits could be used to colocalize or sequester components of a biosynthetic pathway. Post-translational circuit designs remain at the proof-of-concept stage, and there is a need for robust platforms to enable the post-translational control of protein targets.

During this time, synthetic biologists began to use network engineering techniques to address fundamental questions about the form, function and evolutionary plasticity of natural networks. A number of studies used specific, synthetically controlled cellular perturbations to tease apart the design principles of natural regulatory

networks. In one notable study, the native *Bacillus subtilis* circuit that regulates competence was compared with a synthetically rewired version⁷⁷. Although the dynamics of the two circuits were similar, differences in stochastic fluctuations between the two architectures resulted in different patterns of differentiation into the competence state. In another study, the systematic synthetic rewiring of the *E. coli* transcriptional regulatory network showed that the introduction of new network connections had minimal fitness costs and, in some cases, could provide a fitness benefit⁷⁸.

Applications. Metabolic engineering also advanced rapidly during this period, as systems and synthetic biology advances became incorporated into established practices⁷⁹. Taking advantage of the dramatic increase in genome sequence data and the reduction in DNA synthesis costs, groups developed synthetic pathway prediction models to identify favourable metabolic routes based not only on the metabolic system of the host but also on all known and predicted enzymatic functions. Circuit engineers could then forward-engineer the modelled pathway using heterologous enzymes identified by genome mining to fill gaps in the host metabolic system. Recent high-profile successes that use this approach in *E. coli* include rerouting the amino acid biosynthesis pathway to produce isobutanol^{80,81}, fatty acid-based biodiesel⁸² and gasoline⁸³, as well as the bioplastic 1,4-butanediol⁸⁴.

Groups also began to incorporate synthetic regulation into production strains, which enabled the dynamic control of metabolic pathways in response to key metabolic intermediates or environmental conditions⁸⁵. Examples include the use of a synthetic toggle switch and quorum-sensing system to coordinate biomass expansion and ethanol production⁸⁶ and the creation of a fatty acid sensory circuit to regulate convergent ethanol biosynthesis and condensation pathways, resulting in high-yield biodiesel production without the accumulation of excess ethanol⁸⁷.

In a major practical milestone for synthetic biology, large-scale production of the antimalarial drug artemisinin was achieved in early 2013. With funding from the Bill and Melinda Gates Foundation through OneWorld Health and PATH (Program for Appropriate Technology in Health), Amyris Inc. engineered an optimized artemisinic acid pathway in yeast⁸⁸ and licensed it to Sanofi on a royalty-free basis. In turn, Sanofi agreed to produce and supply the drug

Glossary

Abstraction hierarchies

Organizational schemes that simplify the engineering process by describing building blocks according to modular properties, thus enabling the construction of increasingly complex systems. In synthetic biology, molecular elements that are categorized as 'parts' (which is the lowest level of the hierarchy) can be used to construct devices (which are parts assembled together to yield a desired function), which can, in turn, be further combined into systems.

Flux-balance analysis

A mathematical approach to simulate steady-state metabolism in a living system.

Forward-engineer

To move from an abstract description of a desired function to the physical implementation that produces that function. In the context of synthetic biology, it is the construction of genetic systems that produce a desired behaviour.

Logic gate

A device or system that carries out a Boolean logic operation by computing a set of digital inputs to generate a digital output; for example, a genetic circuit that activates gene expression only in the presence of a specified set of environmental signals would constitute an 'AND' gate.

Parts standardization

For an engineering discipline, the adoption of a widely used set of building blocks that have well-defined properties and modes of connectivity.

Reverse-engineer

To examine the constituent components of a system in order to understand their integrated function. In systems biology, this may involve making perturbations to a cellular network and then constructing a model that describes the relationship between the behaviour of the molecular components and that of the entire system.

Systems biology

An interdisciplinary approach that attempts to develop and test holistic models of living systems. A 'top-down' systems approach uses quantitative modelling to identify and describe the underlying biosynthetic and regulatory networks of a system, whereas a complementary 'bottom-up' approach attempts to model the systems-wide phenotypes that emerge from component interactions.

a Relaxation oscillator

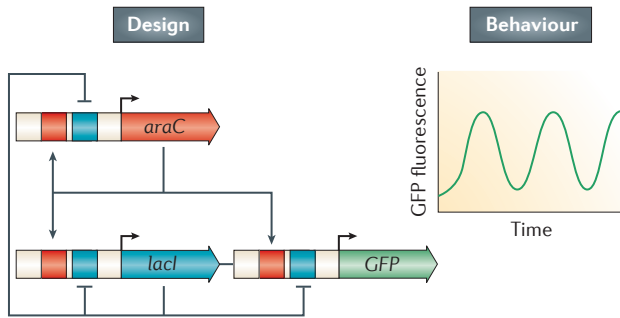

b Recombinase-based logic

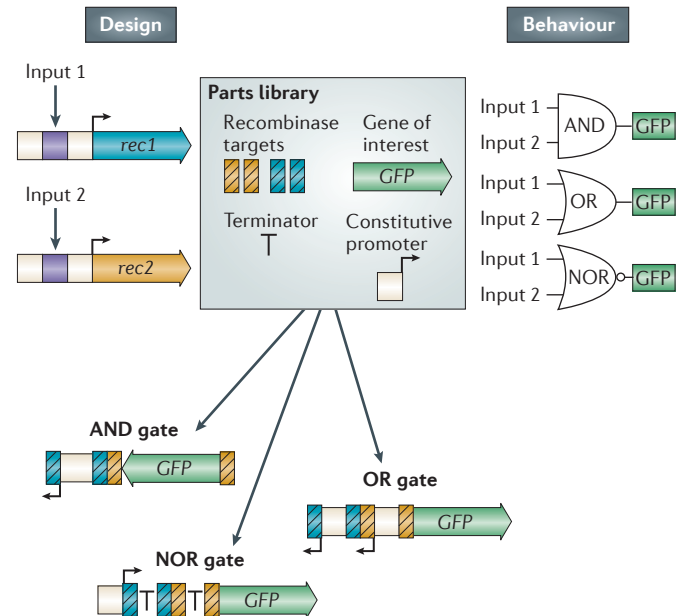

c Edge-detection circuit

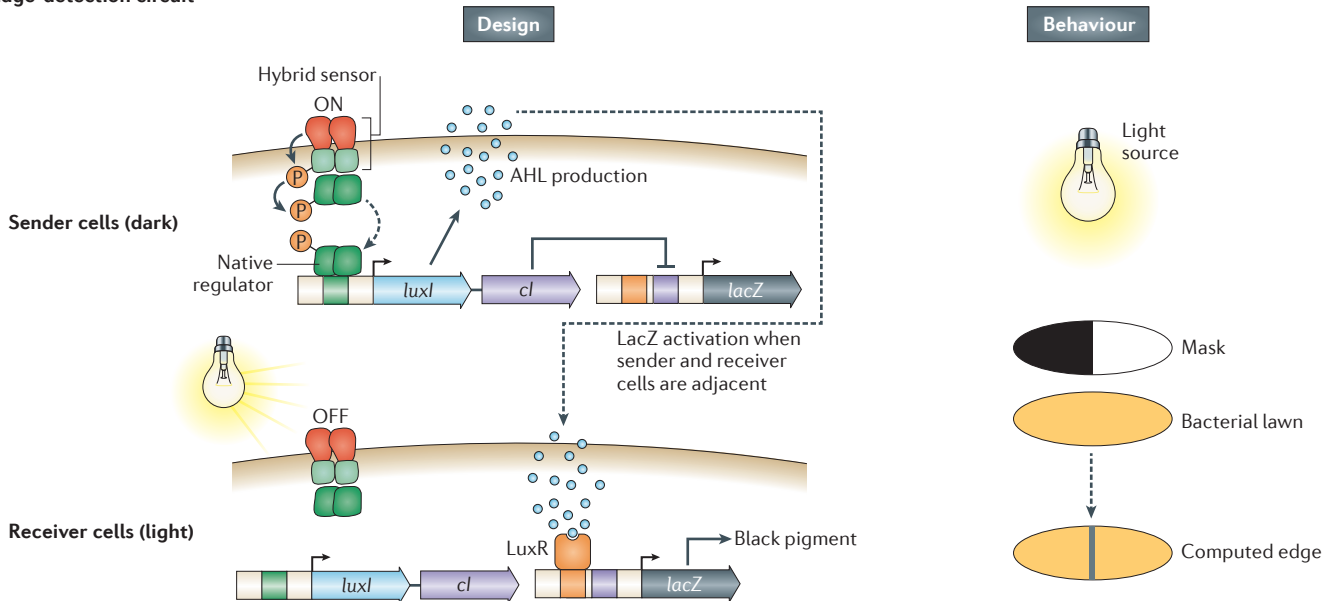

Figure 4 | Examples of gene circuits reported during the most recent era of synthetic biology (2008–2013). **a** | Relaxation oscillator. The circuit uses well-characterized parts (specifically, AraC and LacI) that have been used in previous circuits, but its design is fundamentally different from the ring design of the repressilator (FIG. 2b) and is based instead on overlapping positive- and negative-feedback loops, in which AraC and LacI mediate positive and negative regulation, respectively. Circuit components were assembled on the basis of carefully parameterized modelling, and the circuit was analysed in a microfluidic device to ensure a precisely controlled microenvironment. These key advances resulted in a robust, stable, nearly population-wide oscillatory behaviour over multiple generations. **b** | Recombinase-based logic. These circuits take advantage of recombinase-based DNA inversion and the fundamental directionality of many biological parts to generate logic gate behaviour in genetic circuits. Using a small library of well-characterized parts, all 16 possible logic gates could be constructed. The input modules for the system remain constant, with small molecules used for the induction of the orthogonal recombinases (Rec1 and

Rec2), which cause unidirectional inversion of their target sequences. Depending on the order and orientation of genetic parts in the uninduced circuit, the small molecule inputs produce a GFP output signal, as specified by the corresponding logic gate. For example, the AND-gate circuit only produces a GFP output signal when both inputs are present, causing the constitutive promoter and the GFP gene to be independently inverted such that they are in the appropriate orientation to enable constitutive GFP expression. **c** | Edge-detection circuit. A quorum-sensing system was combined with a hybrid two-component light sensor to compute the edge of an illuminated area. In the circuit, unilluminated bacteria function as sender cells that produce and secrete the quorum-sensing molecule AHL, whereas illuminated bacteria function as receiver cells that cannot produce AHL but can respond to it by expressing the LacZ enzyme to produce a visible black pigment. The illuminated receiver cells can only sense the AHL that is produced by the dark sender cells in regions in which the two cell types are in close proximity — at the edge of an illuminated area — thereby generating a visible outline of the image.

at-cost to patients with malaria in the developing world, providing a low-cost drug that could save many thousands of lives in the years to come.

Additional application-based systems continued to mature during this period⁸⁹, including engineered phage-based therapies^{90–92} and the development of cell-based therapeutic strategies, such as probiotic *E. coli* engineered to identify and kill *Pseudomonas aeruginosa*⁹³ or block *Vibrio cholerae* virulence by expressing a heterologous quorum-sensing signal⁹⁴. Ongoing discussions about the health and security risks of synthetic biology, which are summarized in the [2010 Presidential Bioethics Commission report on synthetic biology](#) (see further information), led to the development of prototype safeguard technologies, such as a programmable microbial kill switch to prevent the release of synthetic microorganisms into the environment⁹⁵.

Whole-genome engineering. During this period, several important steps were taken towards the goal of the comprehensive control of cellular function, as envisioned at the SB1.0 conference. Venter and colleagues used breakthrough DNA-assembly techniques to create a viable bacterial cell that was controlled by a chemically synthesized genome^{49,96}. Synthesized DNA cassettes were assembled by *in vivo* recombination in yeast to recreate the *Mycoplasma mycoides* genome, which was then transplanted into a recipient bacterial cell, resulting in viable bacteria that contained only the synthesized genome. Boeke and colleagues used a similar genome-synthesis approach in yeast, and, in the process of chemical synthesis of two *S. cerevisiae* chromosome arms, they removed all identified transposons and other unstable elements and included recombinase sites flanking every gene⁹⁷.

Genome editing. To enable efficient genomic manipulation, Church and colleagues developed a platform called multiplex automated genome engineering (MAGE), which has been used to rapidly alter multiple loci in the *E. coli* genome⁹⁸, including the proof-of-principle replacement of all TAG stop codons with the synonymous TAA codon⁹⁹. The bacterial CRISPR–Cas system has also been repurposed in bacteria and yeast as a genome-editing tool, in which RNA-directed DNA cleavage is used to select for cells that use homologous recombination to replace the targeted genome sequence with a co-transformed DNA sequence^{100,101}. The remarkable efficiency of the system and

its ability to generate unmarked genomic mutations has the potential to transform bacterial and yeast genetics in the years to come.

Lingering challenges. Despite the accelerated progress of this recent period, the contextual variability of part and circuit performance remained substantial obstacles to efficient model-driven circuit construction. Biomolecular circuit design has essentially remained an ‘artisanal’ craft, unable to achieve the predictability and rapid iteration of design that is characteristic of other engineering disciplines. Although there were some successful efforts at detailed biophysical modelling — notably, a widely used ribosome binding site (RBS) strength calculator that can predict the relative translation rates of target genes¹⁰² — there has also been a gradual acceptance of the variability that is inherent in engineering in a complex intracellular environment.

As groups looked to control or circumvent this biological variability, one general approach has been to generate large parts libraries and carry out detailed measurements to quantify part behaviour. Complex circuits could be combinatorially assembled from selected sets of parts and then screened in parallel. Those that have a desired behaviour could be chosen for application or further improvement¹⁰³. [BIOFAB](#) (International Open Facility Advancing Biotechnology; see further information), which is a biological design–build facility, has led an effort to build and characterize extensive libraries of bacterial promoters, RBS sequences and transcription terminators^{104,105}. By measuring the behaviour of each part in a wide range of genetic contexts, BIOFAB developed a parts ‘reliability score’ that could help to identify potential flaws during both the design and *post hoc* debugging phases of circuit engineering¹⁰⁶.

As an alternative to this extensive characterization approach, other groups have developed methods to focus on reducing genetic complexity, which is a major source of variability in cells. One strategy has been to fully recode target genes and entire operons to remove any undiscovered regulatory elements, such as mRNA secondary structure and small RNAs. This ‘refactoring’ method was used to recode bacteriophage T7 (REF. 107) and to reconstitute the *Klebsiella oxytoca* N₂ fixation system in *E. coli*, in which a synthetic regulatory system was used to control the refactored gene cluster¹⁰⁸. In a related strategy to remove complexity from synthetic circuits, CRISPR and ribozyme-based methods have been

developed to cleave the mRNA of transcribed circuits at target sites flanking each gene, thereby removing the gene from the effects of the 5′ UTR and any co-transcribed genes^{109,110}. This ‘insulating’ system should enable simple models to accurately predict circuit behaviour, thus shortening and potentially eliminating the long, iterative debugging process that continues to bedevil the field.

Outlook for the future

Since its inception more than a decade ago, the field of synthetic biology has grown considerably and has chartered many notable achievements (FIG. 1). The pace of progress in synthetic biology will continue to accelerate as design and testing cycles rely less on the traditional molecular cloning tools that sustained the field in its early years and increasingly on DNA synthesis and high-throughput assembly methods. In the near future, workflow for a biological circuit engineer will no longer be limited by the pace of fabrication but instead by their ability to analyse circuit behaviour and incorporate the data into the next design cycle. As issues of parts characterization and interoperability continue to confound circuit engineering, it will be important to increase the scope and diversity of designs that are tested in each iteration. New technologies and experimental approaches that enable rapid screening or selection of desired circuit functions will also need to be developed. In general, synthetic biology will rely less on analogies to the theory and practice of other engineering disciplines, and will instead continue to build its own identity and culture.

In developing synthetic design and control methods, the field has essentially worked its way forwards through the central dogma of molecular biology, confined in the early years to transcription-based regulatory circuits before developing RNA-based post-transcriptional and translational control systems. However, methods for post-translational regulation are still in their infancy, as a generalized system to control synthetic and endogenous proteins has not yet been reported.

As synthetic systems have become larger and more complex, their interactions with endogenous systems have become more pronounced¹¹¹. Biological circuit engineers will need to develop methods to account for the disparate and often heavy physiological burdens that synthetic systems place on their microbial hosts, perhaps borrowing lessons from metabolic engineering, in

which flux-balance analysis has been used to overcome similar hurdles¹¹².

Synthetic circuit design will (and should) increasingly place emphasis on the ability to use circuits for practical applications. In the context of metabolic engineering, the ability of engineered circuits to interact with cellular systems to dynamically control metabolic flux is one near-term challenge¹¹³. The development of cell-based therapeutic strategies in which engineered microorganisms interface with the human gut microbiota to fight infection and chronic disease is another challenge^{114,115}.

The long-term vision of rational whole-genome engineering remains many years away, but engineering at a genome-wide scale by rewiring cellular networks at multiple loci will increasingly become a focal point of the field. New technologies, such as CRISPR–Cas-mediated genome editing, will enable synthetic biologists to take a more holistic engineering approach, modifying synthetic circuits and the host genome with relative ease¹¹⁶. The technical and cost barriers to synthesizing whole genomes will diminish in the near future, but the field is still far behind on the biological knowledge and mechanistic insights that are needed to construct entirely new regulatory architectures for the creation of a novel synthetic organism.

Despite the proliferation of circuit design and construction methods, there is still very little sharing of circuit constructs between groups, as most synthetic networks are developed and then never used outside the home laboratory. To some extent, this is expected, as many of these circuits are proof-of-principle designs, but as the field moves increasingly towards more complex and application-based designs, an important cultural shift will need to occur, as groups will need to build on the work of others. Therefore, the continued fostering of an inclusive and collaborative community will be essential.

D. Ewen Cameron, Caleb J. Bashor and James J. Collins are at the Howard Hughes Medical Institute, the Center of Synthetic Biology and the Department of Biomedical Engineering, Boston University, Boston, Massachusetts, USA, and the Wyss Institute for Biologically Inspired Engineering, Harvard University, Boston, Massachusetts, USA.

D.E.C. and C.J.B. contributed equally to this work.

Correspondence to J.J.C.
e-mail: jcollins@bu.edu

doi:10.1038/nrmicro3239
Published online 1 April 2014

1. Alberts, B. A grand challenge in biology. *Science* **333**, 1200 (2011).
2. Auslander, S. & Fussenegger, M. From gene switches to mammalian designer cells: present and future prospects. *Trends Biotechnol.* **31**, 155–168 (2013).
3. Karlsson, M. & Weber, W. Therapeutic synthetic gene networks. *Curr. Opin. Biotechnol.* **23**, 703–711 (2012).
4. Monod, J. & Jacob, F. Teleonomic mechanisms in cellular metabolism, growth, and differentiation. *Cold Spring Harb. Symp. Quant. Biol.* **26**, 389–401 (1961).
5. Jacob, F. & Monod, J. On the regulation of gene activity. *Cold Spring Harb. Symp. Quant. Biol.* **26**, 193–211 (1961).
6. Ptashne, M., Johnson, A. D. & Pabo, C. O. A genetic switch in a bacterial virus. *Sci. Am.* **247**, 128–130 (1982).
7. Ideker, T. *et al.* Integrated genomic and proteomic analyses of a systematically perturbed metabolic network. *Science* **292**, 929–934 (2001).
8. Westerhoff, H. V. & Palsson, B. O. The evolution of molecular biology into systems biology. *Nature Biotech.* **22**, 1249–1252 (2004).
9. Jeong, H., Tombor, B., Albert, R. J., Oltvai, Z. N. & Barabasi, A. L. The large-scale organization of metabolic networks. *Nature* **407**, 651–654 (2000).
10. Hartwell, L. H., Hopfield, J. J., Leibler, S. & Murray, A. W. From molecular to modular cell biology. *Nature* **402**, C47–C52 (1999).
11. Bray, D. Protein molecules as computational elements in living cells. *Nature* **376**, 307–312 (1995).
12. Benner, S. A. Synthetic biology: act natural. *Nature* **421**, 118 (2003).
13. McAdams, H. H. & Shapiro, L. Circuit simulation of genetic networks. *Science* **269**, 650–656 (1995).
14. McAdams, H. H. & Arkin, A. Towards a circuit engineering discipline. *Curr. Biol.* **10**, R318–R320 (2000).
15. Gardner, T. S., Cantor, C. R. & Collins, J. J. Construction of a genetic toggle switch in *Escherichia coli*. *Nature* **403**, 339–342 (2000).
16. Elowitz, M. B. & Leibler, S. A synthetic oscillatory network of transcriptional regulators. *Nature* **403**, 335–338 (2000).
17. Hasty, J., McMillen, D., Isaacs, F. & Collins, J. J. Computational studies of gene regulatory networks: in numero molecular biology. *Nature Rev. Genet.* **2**, 268–279 (2001).
18. Kaern, M., Blake, W. J. & Collins, J. J. The engineering of gene regulatory networks. *Annu. Rev. Biomed. Engineer.* **5**, 179–206 (2003).
19. Slusarczyk, A. L., Lin, A. & Weiss, R. Foundations for the design and implementation of synthetic genetic circuits. *Nature Rev. Genet.* **13**, 406–420 (2012).
20. Hasty, J., McMillen, D. & Collins, J. J. Engineered gene circuits. *Nature* **420**, 224–230 (2002).
21. Becskei, A. & Serrano, L. Engineering stability in gene networks by autoregulation. *Nature* **405**, 590–593 (2000).
22. Becskei, A., Seraphin, B. & Serrano, L. Positive feedback in eukaryotic gene networks: cell differentiation by graded to binary response conversion. *EMBO J.* **20**, 2528–2535 (2001).
23. Isaacs, F. J., Hasty, J., Cantor, C. R. & Collins, J. J. Prediction and measurement of an autoregulatory genetic module. *Proc. Natl Acad. Sci. USA* **100**, 7714–7719 (2003).
24. Atkinson, M. R., Savageau, M. A., Myers, J. T. & Ninfa, A. J. Development of genetic circuitry exhibiting toggle switch or oscillatory behavior in *Escherichia coli*. *Cell* **113**, 597–607 (2003).
25. Guet, C. C., Elowitz, M. B., Hsing, W. & Leibler, S. Combinatorial synthesis of genetic networks. *Science* **296**, 1466–1470 (2002).
26. Weiss, R. & Basu, S. The device physics of cellular logic gates. *First Workshop on Non-Silicon Computing* [online], <http://www.hpcaconf.org/hpca8/nsc.pdf> (2002).
27. Ozbudak, E. M., Thattai, M., Kurtser, I., Grossman, A. D. & van Oudenaarden, A. Regulation of noise in the expression of a single gene. *Nature Genet.* **31**, 69–73 (2002).
28. Elowitz, M. B., Levine, A. J., Siggia, E. D. & Swain, P. S. Stochastic gene expression in a single cell. *Science* **297**, 1183–1186 (2002).
29. Blake, W. J., Kaern, M., Cantor, C. R. & Collins, J. J. Noise in eukaryotic gene expression. *Nature* **422**, 633–637 (2003).
30. Weiss, R. & Knight, T. F. Jr. In *DNA Computing* (eds Condon, A. & Rozenberg, G.) 1–16 (Springer, 2001).
31. Park, S. H., Zarrinpar, A. & Lim, W. A. Rewiring MAP kinase pathways using alternative scaffold assembly mechanisms. *Science* **299**, 1061–1064 (2003).
32. Ball, P. Synthetic biology: starting from scratch. *Nature* **431**, 624–626 (2004).
33. Ferber, D. Synthetic biology. Microbes made to order. *Science* **303**, 158–161 (2004).
34. Endy, D. Foundations for engineering biology. *Nature* **438**, 449–453 (2005).
35. Isaacs, F. J. *et al.* Engineered riboregulators enable post-transcriptional control of gene expression. *Nature Biotech.* **22**, 841–847 (2004).
36. Bayer, T. S. & Smolke, C. D. Programmable ligand-controlled riboregulators of eukaryotic gene expression. *Nature Biotech.* **23**, 337–343 (2005).
37. Anderson, J. C., Voigt, C. A. & Arkin, A. P. Environmental signal integration by a modular AND gate. *Mol. Systems Biol.* **3**, 133 (2007).
38. Basu, S., Gerchman, Y., Collins, C. H., Arnold, F. H. & Weiss, R. A synthetic multicellular system for programmed pattern formation. *Nature* **434**, 1130–1134 (2005).
39. You, L., Cox, R. S., 3rd, Weiss, R. & Arnold, F. H. Programmed population control by cell–cell communication and regulated killing. *Nature* **428**, 868–871 (2004).
40. Levskaya, A. *et al.* Synthetic biology: engineering *Escherichia coli* to see light. *Nature* **438**, 441–442 (2005).
41. Martin, V. J., Pitera, D. J., Withers, S. T., Newman, J. D. & Keasling, J. D. Engineering a mevalonate pathway in *Escherichia coli* for production of terpenoids. *Nature Biotech.* **21**, 796–802 (2003).
42. Ro, D. K. *et al.* Production of the antimalarial drug precursor artemisinic acid in engineered yeast. *Nature* **440**, 940–943 (2006).
43. Menzella, H. G. *et al.* Combinatorial polyketide biosynthesis by *de novo* design and rearrangement of modular polyketide synthase genes. *Nature Biotech.* **23**, 1171–1176 (2005).
44. Menzella, H. G. & Reeves, C. D. Combinatorial biosynthesis for drug development. *Curr. Opin. Microbiol.* **10**, 238–245 (2007).
45. Anderson, J. C., Clarke, E. J., Arkin, A. P. & Voigt, C. A. Environmentally controlled invasion of cancer cells by engineered bacteria. *J. Mol. Biol.* **355**, 619–627 (2006).
46. Kwok, R. Five hard truths for synthetic biology. *Nature* **463**, 288–290 (2010).
47. Knight, T. F. Jr. Idempotent vector design for standard assembly of BioBricks. *MIT Synthetic Biology Working Group Technical Reports* [online], <http://web.mit.edu/synbio/release/docs/biobricks.pdf> (2003).
48. Engler, C., Kandzia, R. & Marillonnet, S. A one pot, one step, precision cloning method with high throughput capability. *PLoS ONE* **3**, e3647 (2008).
49. Gibson, D. G. *et al.* Enzymatic assembly of DNA molecules up to several hundred kilobases. *Nature Methods* **6**, 343–345 (2009).
50. Galdzicki, M., Rodriguez, C., Chandran, D., Sauro, H. M. & Gennari, J. H. Standard biological parts knowledgebase. *PLoS ONE* **6**, e17005 (2011).
51. Cardinale, S. & Arkin, A. P. Contextualizing context for synthetic biology — identifying causes of failure of synthetic biological systems. *Biotechnol. J.* **7**, 856–866 (2012).
52. Purnick, P. E. & Weiss, R. The second wave of synthetic biology: from modules to systems. *Nature Rev. Mol. Cell Biol.* **10**, 410–422 (2009).
53. Pauwels, E. & Ifrim, I. In *Synthetic Biology Project* [online], <http://www.synbioproject.org> (Woodrow Wilson International Center for Scholars, 2008).
54. Smolke, C. D. Building outside of the box: iGEM and the BioBricks Foundation. *Nature Biotech.* **27**, 1099–1102 (2009).
55. Voigt, C. A. Life from information. *Nature Methods* **5**, 27–28 (2008).
56. Stricker, J. *et al.* A fast, robust and tunable synthetic gene oscillator. *Nature* **456**, 516–519 (2008).
57. Danino, T., Mondragon-Palmino, O., Tsimring, L. & Hasty, J. A synchronized quorum of genetic clocks. *Nature* **463**, 326–330 (2010).
58. Prindle, A. *et al.* A sensing array of radically coupled genetic 'biopixels'. *Nature* **481**, 39–44 (2012).
59. Friedland, A. E. *et al.* Synthetic gene networks that count. *Science* **324**, 1199–1202 (2009).
60. Siuti, P., Yazbeck, J. & Lu, T. K. Synthetic circuits integrating logic and memory in living cells. *Nature Biotech.* **31**, 448–452 (2013).
61. Bonnet, J., Yin, P., Ortiz, M. E., Subsoontorn, P. & Endy, D. Amplifying genetic logic gates. *Science* **340**, 599–603 (2013).
62. Tamsir, A., Tabor, J. J. & Voigt, C. A. Robust multicellular computing using genetically encoded NOR gates and chemical 'wires'. *Nature* **469**, 212–215 (2011).
63. Moon, T. S., Lou, C., Tamsir, A., Stanton, B. C. & Voigt, C. A. Genetic programs constructed from layered logic gates in single cells. *Nature* **491**, 249–253 (2012).

64. Tabor, J. J. *et al.* A synthetic genetic edge detection program. *Cell* **137**, 1272–1281 (2009).
65. Liu, C. *et al.* Sequential establishment of stripe patterns in an expanding cell population. *Science* **334**, 238–241 (2011).
66. Win, M. N. & Smolke, C. D. Higher-order cellular information processing with synthetic RNA devices. *Science* **322**, 456–460 (2008).
67. Carothers, J. M., Goler, J. A., Juminaga, D. & Keasling, J. D. Model-driven engineering of RNA devices to quantitatively program gene expression. *Science* **334**, 1716–1719 (2011).
68. Na, D. *et al.* Metabolic engineering of *Escherichia coli* using synthetic small regulatory RNAs. *Nature Biotech.* **31**, 170–174 (2013).
69. Wiedenheft, B., Sternberg, S. H. & Doudna, J. A. RNA-guided genetic silencing systems in bacteria and archaea. *Nature* **482**, 331–338 (2012).
70. Qi, L. S. *et al.* Repurposing CRISPR as an RNA-guided platform for sequence-specific control of gene expression. *Cell* **152**, 1173–1183 (2013).
71. Larson, M. H. *et al.* CRISPR interference (CRISPRi) for sequence-specific control of gene expression. *Nature Protoc.* **8**, 2180–2196 (2013).
72. Bikard, D. *et al.* Programmable repression and activation of bacterial gene expression using an engineered CRISPR–Cas system. *Nucleic Acids Res.* **41**, 7429–7437 (2013).
73. Bashor, C. J., Helman, N. C., Yan, S. & Lim, W. A. Using engineered scaffold interactions to reshape MAP kinase pathway signaling dynamics. *Science* **319**, 1539–1543 (2008).
74. Whitaker, W. R., Davis, S. A., Arkin, A. P. & Dueber, J. E. Engineering robust control of two-component system phosphotransfer using modular scaffolds. *Proc. Natl Acad. Sci. USA* **109**, 18090–18095 (2012).
75. Dueber, J. E. *et al.* Synthetic protein scaffolds provide modular control over metabolic flux. *Nature Biotech.* **27**, 753–759 (2009).
76. Chau, A. H., Walter, J. M., Gerardin, J., Tang, C. & Lim, W. A. Designing synthetic regulatory networks capable of self-organizing cell polarization. *Cell* **151**, 320–332 (2012).
77. Cagatay, T., Turcotte, M., Elowitz, M. B., Garcia-Ojalvo, J. & Suel, G. M. Architecture-dependent noise discriminates functionally analogous differentiation circuits. *Cell* **139**, 512–522 (2009).
78. Isalan, M. *et al.* Evolvability and hierarchy in rewired bacterial gene networks. *Nature* **452**, 840–845 (2008).
79. Lee, J. W. *et al.* Systems metabolic engineering of microorganisms for natural and non-natural chemicals. *Nature Chem. Biol.* **8**, 536–546 (2012).
80. Atsumi, S., Hanai, T. & Liao, J. C. Non-fermentative pathways for synthesis of branched-chain higher alcohols as biofuels. *Nature* **451**, 86–89 (2008).
81. Huo, Y. X. *et al.* Conversion of proteins into biofuels by engineering nitrogen flux. *Nature Biotech.* **29**, 346–351 (2011).
82. Steen, E. J. *et al.* Microbial production of fatty-acid-derived fuels and chemicals from plant biomass. *Nature* **463**, 559–562 (2010).
83. Choi, Y. J. & Lee, S. Y. Microbial production of short-chain alkanes. *Nature* **502**, 571–574 (2013).
84. Yim, H. *et al.* Metabolic engineering of *Escherichia coli* for direct production of 1,4-butanediol. *Nature Chem. Biol.* **7**, 445–452 (2011).
85. Holtz, W. J. & Keasling, J. D. Engineering static and dynamic control of synthetic pathways. *Cell* **140**, 19–23 (2010).
86. Anesiadis, N., Cluett, W. R. & Mahadevan, R. Dynamic metabolic engineering for increasing bioprocess productivity. *Metab. Eng.* **10**, 255–266 (2008).
87. Zhang, F., Carothers, J. M. & Keasling, J. D. Design of a dynamic sensor–regulator system for production of chemicals and fuels derived from fatty acids. *Nature Biotech.* **30**, 354–359 (2012).
88. Paddon, C. J. *et al.* High-level semi-synthetic production of the potent antimalarial artemisinin. *Nature* **496**, 528–532 (2013).
89. Ruder, W. C., Lu, T. & Collins, J. J. Synthetic biology moving into the clinic. *Science* **333**, 1248–1252 (2011).
90. Lu, T. K. & Collins, J. J. Dispersing biofilms with engineered enzymatic bacteriophage. *Proc. Natl Acad. Sci. USA* **104**, 11197–11202 (2007).
91. Lu, T. K., Khalil, A. S. & Collins, J. J. Next-generation synthetic gene networks. *Nature Biotech.* **27**, 1139–1150 (2009).
92. Lu, T. K., Bowers, J. & Koeris, M. S. Advancing bacteriophage-based microbial diagnostics with synthetic biology. *Trends Biotechnol.* **31**, 325–327 (2013).
93. Gupta, S., Bram, E. E. & Weiss, R. Genetically programmable pathogen sense and destroy. *ACS Synth. Biol.* **2**, 715–723 (2013).
94. Duan, F. & March, J. C. Engineered bacterial communication prevents *Vibrio cholerae* virulence in an infant mouse model. *Proc. Natl Acad. Sci. USA* **107**, 11260–11264 (2010).
95. Callura, J. M., Dwyer, D. J., Isaacs, F. J., Cantor, C. R. & Collins, J. J. Tracking, tuning, and terminating microbial physiology using synthetic riboregulators. *Proc. Natl Acad. Sci. USA* **107**, 15898–15903 (2010).
96. Gibson, D. G. *et al.* Creation of a bacterial cell controlled by a chemically synthesized genome. *Science* **329**, 52–56 (2010).
97. Dymond, J. S. *et al.* Synthetic chromosome arms function in yeast and generate phenotypic diversity by design. *Nature* **477**, 471–476 (2011).
98. Wang, H. H. *et al.* Programming cells by multiplex genome engineering and accelerated evolution. *Nature* **460**, 894–898 (2009).
99. Isaacs, F. J. *et al.* Precise manipulation of chromosomes *in vivo* enables genome-wide codon replacement. *Science* **333**, 348–353 (2011).
100. Jiang, W., Bikard, D., Cox, D., Zhang, F. & Marraffini, L. A. RNA-guided editing of bacterial genomes using CRISPR–Cas systems. *Nature Biotech.* **31**, 233–239 (2013).
101. DiCarlo, J. E. *et al.* Genome engineering in *Saccharomyces cerevisiae* using CRISPR–Cas systems. *Nucleic Acids Res.* **41**, 4336–4343 (2013).
102. Salis, H. M., Mirsky, E. A. & Voigt, C. A. Automated design of synthetic ribosome binding sites to control protein expression. *Nature Biotech.* **27**, 946–950 (2009).
103. Ellis, T., Wang, X. & Collins, J. J. Diversity-based, model-guided construction of synthetic gene networks with predicted functions. *Nature Biotech.* **27**, 465–471 (2009).
104. Mutalik, V. K. *et al.* Precise and reliable gene expression via standard transcription and translation initiation elements. *Nature Methods* **10**, 354–360 (2013).
105. Cambrey, G. *et al.* Measurement and modeling of intrinsic transcription terminators. *Nucleic Acids Res.* **41**, 5139–5148 (2013).
106. Mutalik, V. K. *et al.* Quantitative estimation of activity and quality for collections of functional genetic elements. *Nature Methods* **10**, 347–353 (2013).
107. Chan, L. Y., Kosuri, S. & Endy, D. Refactoring bacteriophage T7. *Mol. Systems Biol.* **1**, 2005.0018 (2005).
108. Temme, K., Zhao, D. & Voigt, C. A. Refactoring the nitrogen fixation gene cluster from *Klebsiella oxytoca*. *Proc. Natl Acad. Sci. USA* **109**, 7085–7090 (2012).
109. Qi, L., Haurwitz, R. E., Shao, W., Doudna, J. A. & Arkin, A. P. RNA processing enables predictable programming of gene expression. *Nature Biotech.* **30**, 1002–1006 (2012).
110. Lou, C., Stanton, B., Chen, Y. J., Munsky, B. & Voigt, C. A. Ribozyme-based insulator parts buffer synthetic circuits from genetic context. *Nature Biotech.* **30**, 1137–1142 (2012).
111. Cookson, N. A. *et al.* Queuing up for enzymatic processing: correlated signaling through coupled degradation. *Mol. Systems Biol.* **7**, 561 (2011).
112. Feist, A. M. & Palsson, B. O. The biomass objective function. *Curr. Opin. Microbiol.* **13**, 344–349 (2010).
113. Callura, J. M., Cantor, C. R. & Collins, J. J. Genetic switchboard for synthetic biology applications. *Proc. Natl Acad. Sci. USA* **109**, 5850–5855 (2012).
114. Holmes, E. *et al.* Therapeutic modulation of microbiota–host metabolic interactions. *Sci. Transl. Med.* **4**, 137rv6 (2012).
115. Sonnenburg, J. L. & Fischbach, M. A. Community health care: therapeutic opportunities in the human microbiome. *Sci. Transl. Med.* **3**, 78ps12 (2011).
116. Esvelt, K. M. & Wang, H. H. Genome-scale engineering for systems and synthetic biology. *Mol. Systems Biol.* **9**, 641 (2013).
117. Goffeau, A. *et al.* Life with 6000 genes. *Science* **274**, 563–567 (1996).
118. Blattner, F. R. *et al.* The complete genome sequence of *Escherichia coli* K-12. *Science* **277**, 1453–1462 (1997).

Acknowledgements

The authors thank T. Lu and J. Dueber for helpful discussions during the preparation of this Perspective article. This work is supported by the Howard Hughes Medical Institute.

Competing interests statement

The authors declare no competing interests.

FURTHER INFORMATION

2010 Presidential Bioethics Commission report on synthetic biology: <http://bioethics.gov/synthetic-biology-report>
 The BioBricks Foundation: <http://biobricks.org>
 BIOFAB: <http://biofab.synberc.org>
 iGEM: <http://igem.org>
 Nature Reviews Microbiology Focus on Synthetic Biology: <http://www.nature.com/nrmicro/focus/synbio>
 OpenWetWare: <http://openwetware.org>
 Registry of Standard Biological Parts: <http://parts.igem.org>
 SynBERC: <http://synberc.org>
 Synthetic Biology Open Language standard: <http://www.sbolstandard.org>

ALL LINKS ARE ACTIVE IN THE ONLINE PDF